



NOTICE of FILING

LAND USE REQUEST AFFECTING THIS AREA

There is a development proposal for the property listed in this notice and shown on the attached map. The City is seeking input from neighbors on the proposal. If you have questions or comments about the proposal, contact the case manager.

Esta carta es un aviso sobre una propuesta de desarrollo para la propiedad enumerada y que se muestra en el mapa adjunto. La ciudad está buscando la opinión de los vecinos sobre la propuesta. Si tiene preguntas o comentarios sobre la propuesta, póngase en contacto con nosotros al 503-588-6213.

CASE NUMBER:	Class 3 Site Plan Review / Class 2 Adjustment / Class 2 Driveway Approach Permit / Class 1 Design Review Case No. SPR-ADJ-DAP-DR21-13
PROPERTY LOCATION:	1610 Lancaster Dr SE, Salem OR 97317
NOTICE MAILING DATE:	May 5, 2021
PROPOSAL SUMMARY:	A proposal to construct a 6-unit apartment building while retaining an existing single family dwelling.
COMMENT PERIOD:	All written comments must be submitted to City Staff no later than 5:00 p.m. Wednesday, May 19, 2021. Please direct any questions and/or comments about the case to the Case Manager listed below.
CASE MANAGER:	Brandon Pike, Planner I , City of Salem Planning Division, 555 Liberty Street SE, Room 305, Salem, Oregon 97301. Telephone: 503-540-2326; E-mail: bpike@cityofsalem.net
NEIGHBORHOOD ASSOCIATION:	<i>Neighborhood associations are volunteer organizations of neighbors coming together to make neighborhoods the best they can be. They receive notice of land use applications within their boundaries, and they often submit comments on the applications to the City. Neighborhood association meetings are open to everyone. Contact your neighborhood association to get involved:</i> Southeast Mill Creek Association (SEMCA), Alan Rasmussen, Land Use Chair; Phone: 503-930-1968; Email: arasmussen@modernbuildingsystems.com .
ACCESS:	The Americans with Disabilities Act (ADA) accommodations will be provided on request.
CRITERIA TO BE CONSIDERED:	Salem Revised Code (SRC) Chapter(s) 220.005(f)(3) – Class 3 Site Plan Review; 250.005(d)(2) – Class 2 Adjustment; 804.025(d) – Class 2 Driveway Approach Permit; 225.005(e)(1) – Class 1 Design Review Salem Revised Code (SRC) is available to view at this link: http://bit.ly/salemorcode . Type in the chapter number(s) listed above to view the applicable criteria.

PROPERTY OWNER(S):	1610 Lancaster Drive SE LLC (Jeffrey Starkey)
APPLICANT(S):	Zach Pelz, AKS Engineering and Forestry, LLC, on behalf of Jordan Schweiger, Good Well Construction, Inc.
PROPOSAL REQUEST:	<p>A consolidated application containing a Class 3 Site Plan Review and Class 1 Design Review for the development of a new apartment building with associated site improvements, a Class 2 Driveway Approach Permit to allow driveway access onto 40th Place SE, and Class 2 Adjustment requests to:</p> <ol style="list-style-type: none"> 1) Reduce the minimum setback for buildings to the north property line from 10 feet to 6 feet; 2) Reduce the minimum setback for vehicle use areas to the south property line from 10 feet to 4.67 feet; 3) Allow a portion of an off-street parking area to be located between a building and a street; and 4) Adjust a vision clearance area for the proposed driveway approach. <p>The subject property is approximately 0.40 acres in size, zoned RM-II (Multiple Family Residential-II), and located at 1610 Lancaster Drive SE (Marion County Assessor map and tax lot number(s): 082W06AB / 9200).</p>
APPLICATION PROCESS:	<p>Following the close of the Public Comment Period, a decision will be issued and mailed to the applicant, property owner, affected neighborhood association, anyone who submitted written comments, and anyone who received notice of the land use request.</p> <p>Failure to raise an issue in writing prior to the close of the Public Comment Period with sufficient specificity to provide the opportunity to respond to the issue, precludes appeal to the Land Use Board of Appeals (LUBA) on this issue. A similar failure to raise constitutional issues relating to proposed conditions of approval precludes an action for damages in circuit court.</p>
MORE INFORMATION:	<p>Documents and evidence submitted by the applicant are available for review and paper copies can be obtained at a reasonable cost. You can also find out more information about the status of the proposed application on the City's online Permit Application Center at https://permits.cityofsalem.net. Just enter the permit number listed here: 21 101664, 21 101693, 21 101669, 21 101667</p>

PLEASE PROMPTLY FORWARD A COPY OF THIS NOTICE TO ANY OTHER OWNER, TENANT OR LESSEE

For more information about Planning in Salem:

<http://www.cityofsalem.net/planning>

It is the City of Salem's policy to assure that no person shall be discriminated against on the grounds of race, religion, color, sex, marital status, familial status, national origin, age, mental or physical disability, sexual orientation, gender identity and source of income, as provided by Salem Revised Code Chapter 97. The City of Salem also fully complies with Title VI of the Civil Rights Act of 1964, and related statutes and regulations, in all programs and activities. Disability-related modification or accommodation, including auxiliary aids or services, in order to participate in this meeting or event, are available upon request. Sign language and interpreters for languages other than English are also available upon request. To request such an accommodation or interpretation, contact the Community Development Department at 503-588-6173 at least three business days before this meeting or event.

TTD/TTY telephone 503-588-6439 is also available 24/7

REQUEST FOR COMMENTS

Si necesita ayuda para comprender esta informacion, por favor llame 503-588-6173

REGARDING: Class 3 Site Plan Review / Class 2 Adjustment / Class 2 Driveway Approach Permit / Class 1 Design Review Case No. SPR-ADJ-DAP-DR21-13

PROJECT ADDRESS: 1610 Lancaster Dr SE, Salem OR 97317

AMANDA Application No.: 21-101664-RP, 21-101693-ZO, 21-101669-ZO, 21-101667-DR

COMMENT PERIOD ENDS: May 19, 2021

SUMMARY: A proposal to construct a 6-unit apartment building while retaining an existing single family dwelling.

REQUEST: A consolidated application containing a Class 3 Site Plan Review and Class 1 Design Review for the development of a new apartment building with associated site improvements, a Class 2 Driveway Approach Permit to allow driveway access onto 40th Place SE, and Class 2 Adjustment requests to:

- 1) Reduce the minimum setback for buildings to the north property line from 10 feet to 6 feet;
- 2) Reduce the minimum setback for vehicle use areas to the south property line from 10 feet to 4.67 feet;
- 3) Allow a portion of an off-street parking area to be located between a building and a street; and
- 4) Adjust a vision clearance area for the proposed driveway approach.

The subject property is approximately 0.40 acres in size, zoned RM-II (Multiple Family Residential-II), and located at 1610 Lancaster Drive SE (Marion County Assessor map and tax lot number(s): 082W06AB / 9200).

The Planning Division is interested in hearing from you about the attached proposal. Staff will prepare a Decision that includes consideration of comments received during this comment period. We are interested in receiving pertinent, factual information such as neighborhood association recommendations and comments of affected property owners or residents. The complete case file, including all materials submitted by the applicant and any applicable professional studies such as traffic impact analysis, geologic assessments, and stormwater reports, are available upon request.

Comments received by 5:00 p.m. Wednesday, May 19, 2021, will be considered in the decision process. Comments received after this date will be not considered. ****PLEASE NOTE: City offices have very limited staffing due to COVID-19. To ensure that your comments are received by the deadline, we recommend that you e-mail your comments to the Case Manager listed below.****

CASE MANAGER: Brandon Pike, Planner I, Phone: 503-540-2326; E-Mail: bpike@cityofsalem.net.

For information about Planning in Salem, please visit: <http://www.cityofsalem.net/planning>

PLEASE CHECK THE FOLLOWING THAT APPLY:

1. I have reviewed the proposal and have no objections to it.
2. I have reviewed the proposal and have the following comments: _____
- _____
- _____
- _____

Name/Agency: _____

Address: _____

Phone: _____

Email: _____

Date: _____

IMPORTANT: IF YOU MAIL COMMENTS, PLEASE FOLD AND RETURN THIS POSTAGE-PAID FORM



NO POSTAGE
NECESSARY
IF MAILED
IN THE
UNITED STATES

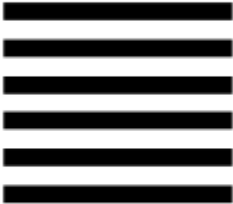

BUSINESS REPLY MAIL
FIRST-CLASS MAIL PERMIT NO. 1508 SALEM, OR

POSTAGE WILL BE PAID BY ADDRESSEE





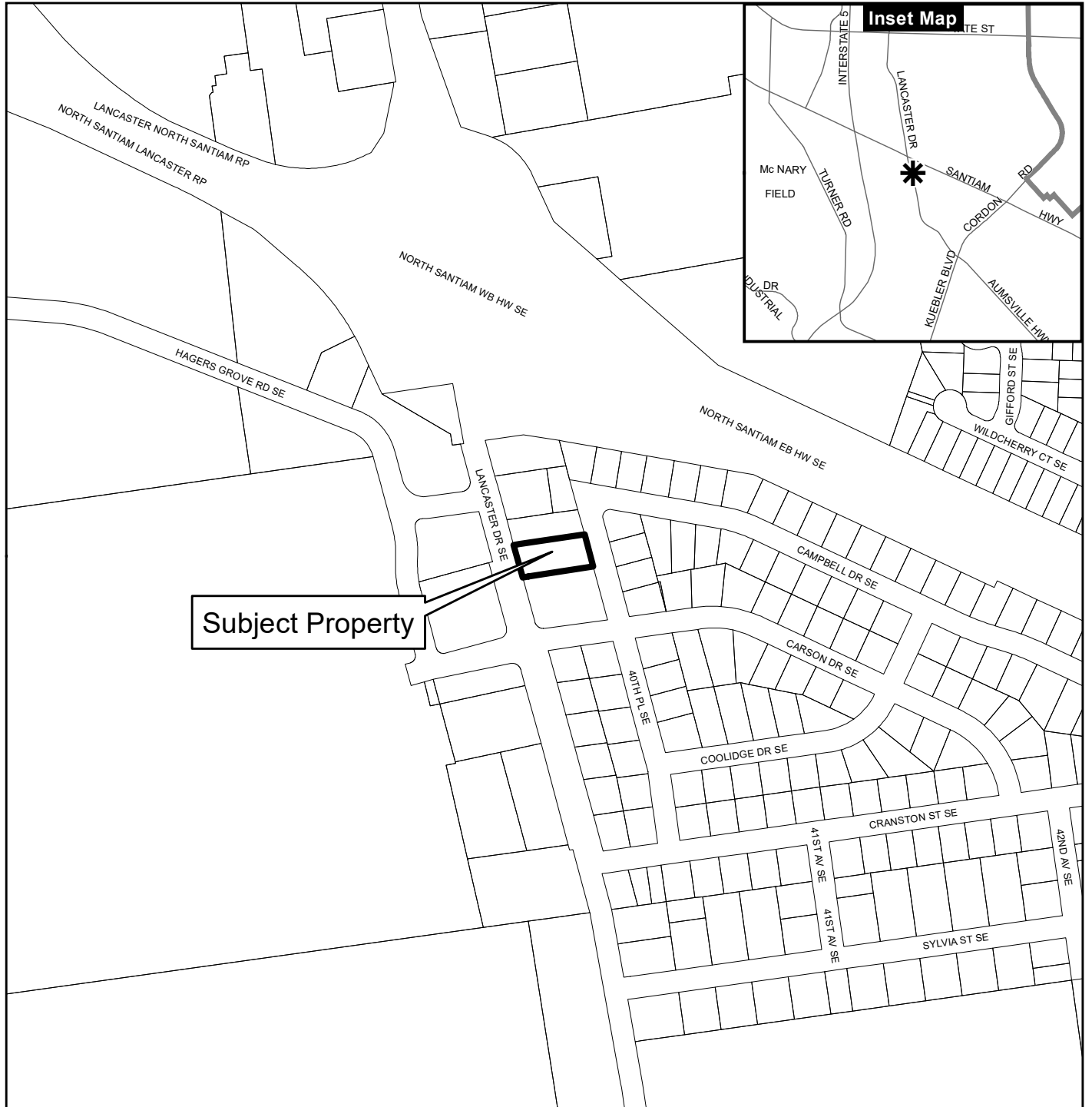

PLANNING DIVISION
CITY OF SALEM RM 305
555 LIBERTY ST SE
SALEM OR 97301-9907



Vicinity Map 1610 Lancaster Dr SE



Legend

-  Taxlots
-  Urban Growth Boundary
-  City Limits
-  Outside Salem City Limits
-  Historic District
-  Schools
-  Parks



0 100 200 400 Feet



This product is provided as is, without warranty. In no event is the City of Salem liable for damages from the use of this product. This product is subject to license and copyright limitations and further distribution or resale is prohibited.

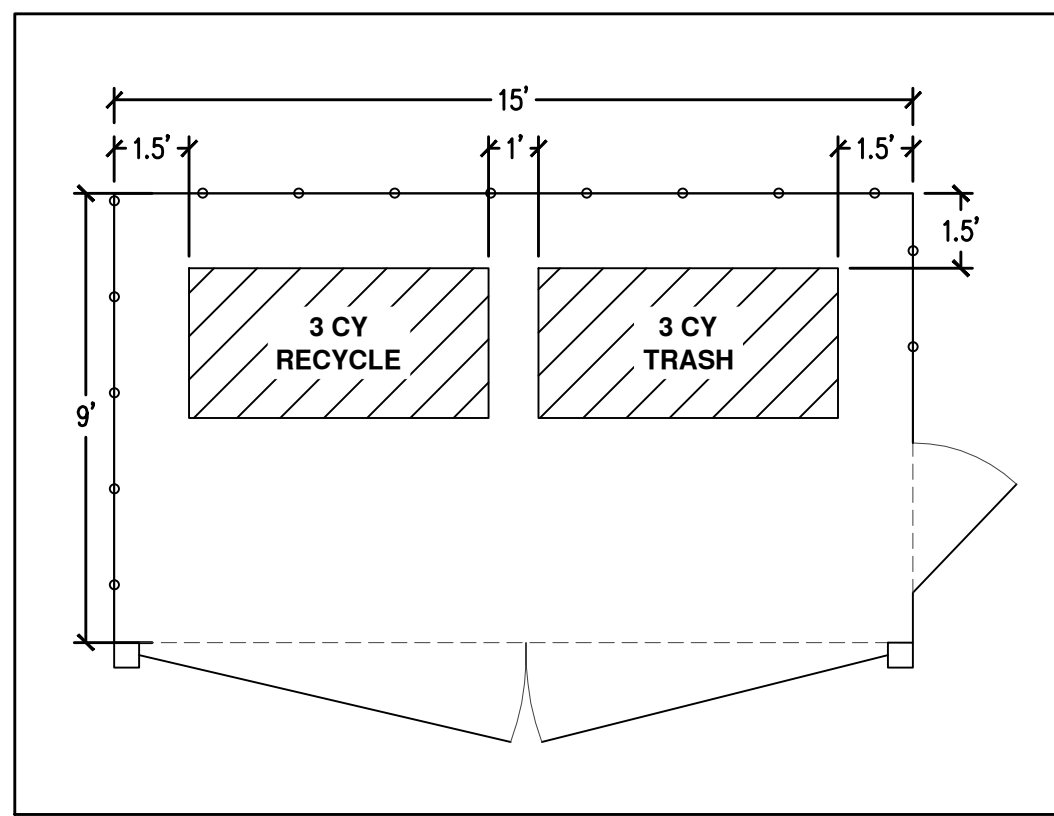

TRASH ENCLOSURE DETAIL
NTS

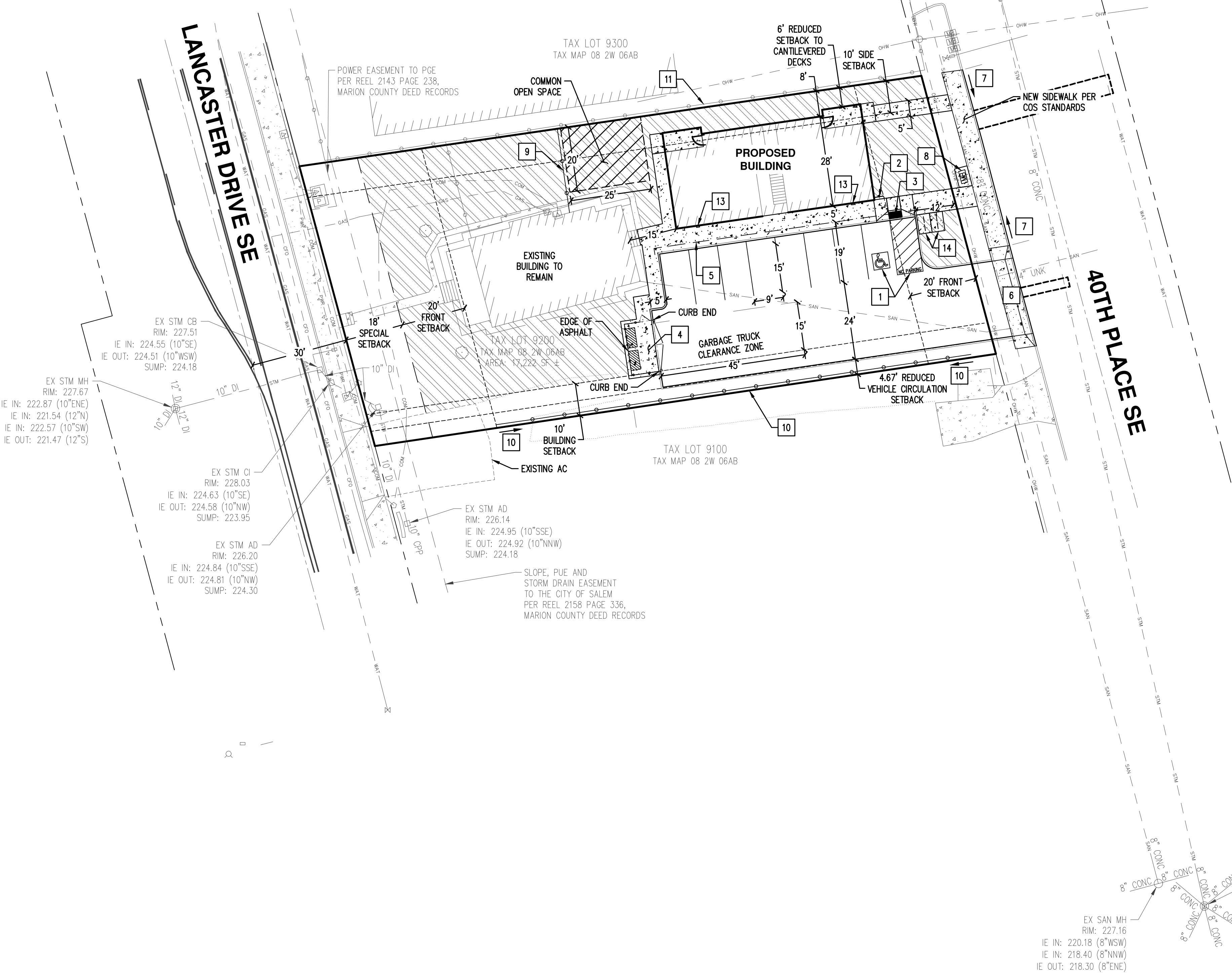

SITE SUMMARY:

GROSS SITE AREA = 0.40± ACRES (17,222± SF)
 ZONE = MULTIPLE FAMILY RESIDENTIAL-II
 MINIMUM DENSITY = 12 UNITS/ACRE
 MAXIMUM DENSITY = 28 UNITS/ ACRE
 PROPOSED DENSITY = 17.5 UNITS/ACRE

BUILDING SUMMARY:

EXISTING BUILDING:
 USE = SINGLE FAMILY RESIDENTIAL HOME
 GROSS FLOOR AREA = 1,359± SF
 HEIGHT = UNKNOWN

PROPOSED BUILDING:
 USE = MULTIPLE FAMILY RESIDENTIAL APARTMENT
 GROSS FLOOR AREA = 4,428 (1,476 SF/FLOOR)
 HEIGHT = 33.5'

LOT COVERAGE SUMMARY:

BUILDING COVERAGE = 3,185± SF
 PAVED AREAS (PARKING AND SIDEWALKS) = 5,600± SF
 LANDSCAPED AREAS = 8,437± SF
 % IMPERVIOUS AREA = 51%
 % PERVIOUS AREA = 49%

OPEN SPACE SUMMARY:

COMMON OPEN SPACE REQUIRED = 500 SF WITH 20' MINIMUM DIMENSION
 COMMON OPEN SPACE PROVIDED = 500 SF
 GROSS OPEN SPACE REQUIRED = 3,445 SF (20% OF GROSS SITE AREA)
 GROSS OPEN SPACE PROVIDED = 5,505± SF (31% OF GROSS SITE AREA)

OPEN SPACE LEGEND:

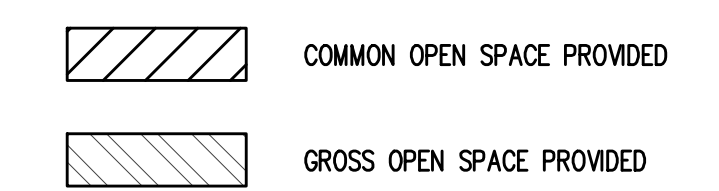

PARKING SUMMARY:

OFF-STREET PARKING REQUIRED:
 1BR @ 1 SP/UNIT (7 UNITS) = 7 SPACES
 TOTAL PARKING REQUIRED = 7 SPACES

OFF-STREET PARKING PROVIDED = 8 SPACES
 (INCLUDES 1 ACCESSIBLE STALL AND 2 COMPACT STALLS)

BICYCLE PARKING REQUIRED = 4 SPACES
 BICYCLE PARKING PROVIDED = 4 SPACES

SETBACK SUMMARY:

SPECIAL SETBACK (LANCASTER DRIVE) 48' FROM ϵ = 18'
 FRONT SETBACK (LANCASTER DRIVE) = 20'
 FRONT SETBACK (40TH PLACE) = 20'
 SIDE SETBACKS (NORTH/SOUTH) = 10'
 REDUCED SETBACKS:
 SIDE SETBACK (NORTH) = 6'
 SIDE SETBACK (SOUTH) = 4.67' (VEHICLE CIRCULATION)

KEYED NOTES:

1. ACCESSIBLE STALL AND ACCESSIBLE STRIPING
2. ACCESSIBLE PARKING SIGN
3. PEDESTRIAN CURB RAMP
4. TRASH ENCLOSURE
5. 2' BUMPER OVERHANG
6. COMMERCIAL DRIVEWAY APPROACH PER CITY STANDARDS
7. 6' SIDEWALK PER CITY STANDARDS. CURB TO REMAIN
8. MAILBOX PER USPS REQUIREMENTS
9. 4' CHAIN LINK FENCE
10. 6' SITE OBSCURING FENCE 1' NORTH OF PROPERTY LINE
11. SITE OBSCURING FENCE AT PROPERTY LINE TO REMAIN
12. NOT USED
13. WALL PACK LIGHT WITH SHIELDING PER CITY STANDARDS
14. STAPLE BIKE RACK ON 6' X 8' CONCRETE PAD

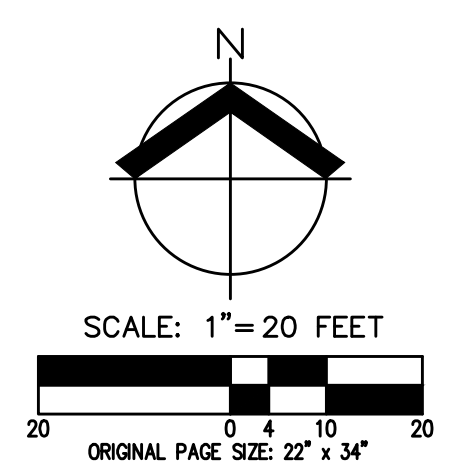

**PRELIMINARY SITE PLAN
1610 LANCASTER DR SE
SITE PLAN REVIEW
SALEM, OREGON**



JOB NUMBER:	8106
DATE:	03/22/2021
DESIGNED BY:	TDR
DRAWN BY:	SLZ/KNU
CHECKED BY:	RCW

C100

ADDITIONAL METHOD CHOICE:
 ENVELOPE : 2
 CONSERVATION : C
 SEE PAGE : 5

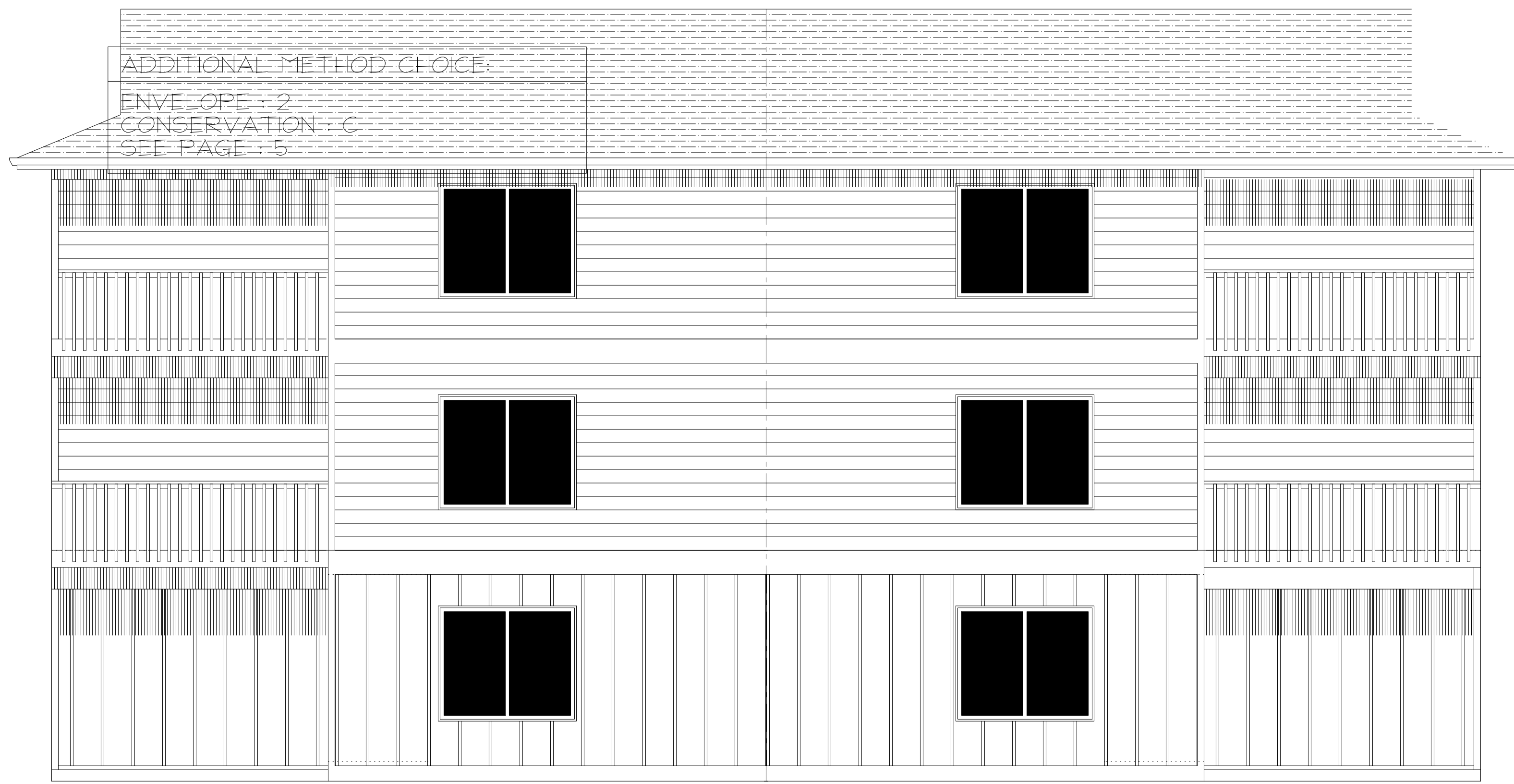

NORTH ELEVATION



40TH PL ELEVATION

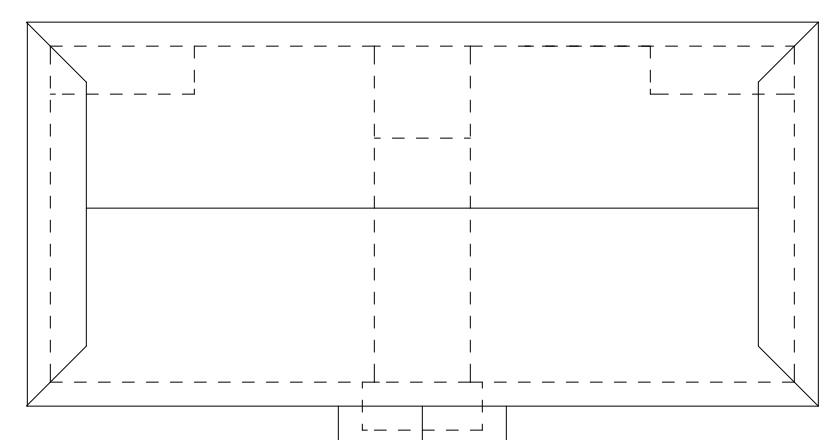

1ST LEVEL : 708 SQ FT
 2ND LEVEL : 708 SQ FT
 3RD LEVEL : 708 SQ FT
 TOTAL LIVING AREA :

2017 Oregon Residential Specialty Code

EXPOSURE : B
 BASIC WIND SPEED : 120 MPH (UMS)
 SEISMIC DESIGN CATEGORY : DI

LATERAL DESIGN STANDARDS



WEST ELEVATION



SOUTH ELEVATION

1/4"=1'0"

REVISION	BY

Greg Larson
 DRAFTING & DESIGN
 289 E Ellendale Ave #402
 Dallas, Oregon 97138
 Phone: (503) 364-8577
 Fax: (503) 364-3256
 E-MAIL: homedezyme@aol.com

GOOD WELL CONSTRUCTION INC.
 Jordan Schweiger
 503-375-6205
 CCP#: 715065

ELEVATIONS

RESIDENCE FOR :
 ADDRESS : 1610 LANCASTER SE
 CITY, STATE : SALEM, OR

DRAWN BY : GLL
 CHECKED BY :
 DATE : 10-27-20
 SCALE : 1/4" = 1'-0"
 JOB NO. : 5-708-3
 SHEET : 1 OF : 5